

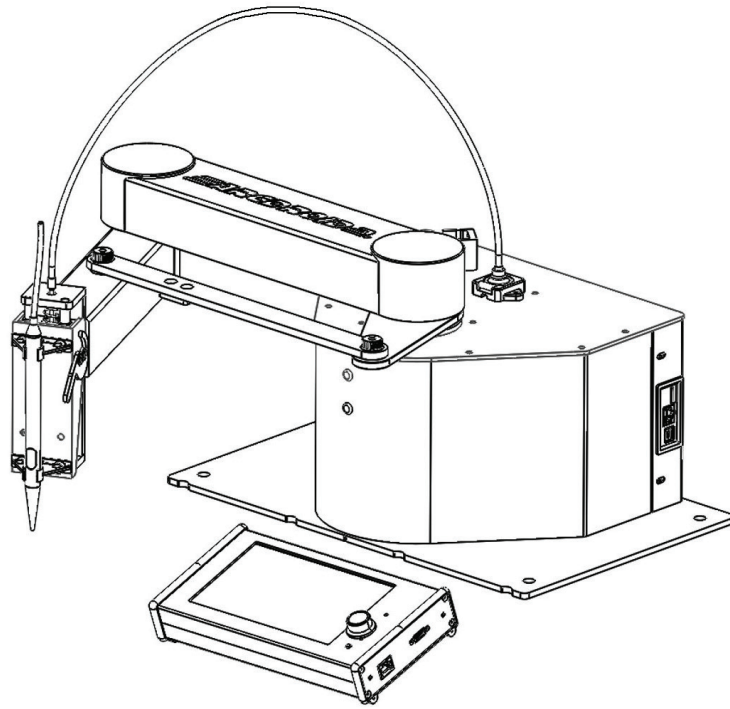

# Operations Manual

## CNC Plasma Robot



**TRACE IT. SAVE IT. CUT IT.**

Supplied by



Setting the standard for quality & value

[www.machineryhouse.com.au](http://www.machineryhouse.com.au)  
[www.machineryhouse.co.nz](http://www.machineryhouse.co.nz)

Safety Precautions.....	page 3
Quick Start Guide .....	page 4
1.0 Calibrating your ArcDroid™.....	page 7
1.1 Inspecting the Sled Slide Switch.....	page 7
1.2 Calibrating the X / Y Axis.....	page 7
1.3 Calibrating the Z Axis.....	page 11
2.0 Connecting your Plasma Cutter to the ArcDroid™ .....	page 12
3.0 Setting up the ArcDroid™ to run .....	page 13
3.1 Establish X, Y ZERO POSITION of your workpiece .....	page 13
4.0 Using Simple Trace™ .....	page 14
4.1 Making Cut files on the ArcDroid™ .....	page 14
4.2 Editing Cut files on the ArcDroid™ .....	page 16
4.3 Loading Cut files into the ArcDroid™ .....	page 16
5.0 Programming the ArcDroid™ using G-Codes & M-Codes at a Computer.....	page 16
6.0 Manual G-CODE entry on the ArcDroid™ .....	page 16
7.0 Setting the Date and Time.....	page 16
8.0 ArcDroid™ G-CODE & M-CODE Reference List.....	page 17
9.0 Pro Tips .....	page 18
10.0 Troubleshooting and Maintenance .....	page 19

## Safety Precautions

ArcDroid™ CNC has endeavoured to produce the best possible equipment and we hope that it becomes an indispensable tool in your workshop. With proper use and care your product should deliver years of trouble free service.



### Safe operation and maintenance is your responsibility!

Although the ArcDroid™ is not inherently dangerous, it is designed to operate in conjunction with high voltage plasma cutting equipment so some basic safety precautions should be observed.

Failure to observe these precautions could result in severe injury



Keep hands etc. away from moving parts while the ArcDroid™ is operating



ArcDroid™ may not be compatible with high frequency plasma cutters. HF plasma can cause interference making for unpredictable results



Protect the ArcDroid™ screen from sparks and debris



Never look directly into the plasma arc without protective shielding



Plasma cutting releases a lot of UV radiation take care to protect yourself



Gloves at all times, metal can be hot!



Always protect your eyes with wrap around safety glasses



Always read and understand the manufacturers instructions for any equipment you use in conjunction with the ArcDroid™



Plasma cutters operate using high voltages  
Never connect your ArcDroid™ directly to plasma arc voltage



ArcDroid™ should be protected from moisture

Always store your ARCDROID™ upright in a dry environment. Secure arms before transport, care should be taken to avoid damage to the TFT screen and Z drive cable.

**STEP 1:** Before attempting a cut with your ArcDroid™ you must run the calibration routine to match you plasma cutter position to the internal inverse kinematics equation. Failure to calibrate will result in inaccurate cut profiles.

Visit us at [YouTube.com/arcdroidcnc](https://www.youtube.com/arcdroidcnc) to see a video on how to calibrate your ArcDroid™

The calibration routine can be accessed via Settings -> Calibrate. Calibration requires the cutting head to be firmly attached to the Z carrier plate of the ArcDroid™. If the cutting head is removed and reinstalled to the carrier plate it is recommended to repeat the calibration sequence. Moving the carrier plate with cutting head firmly attached on and off the ArcDroid™ Z drive does not require re-calibration.

**STEP 2:** In order for the ArcDroid™ to activate the plasma on/off a simple two wire connection to the back of the ArcDroid™ must be established.

Visit us at [YouTube.com/arcdroidcnc](https://www.youtube.com/arcdroidcnc) to see a video on connecting your ArcDroid™

NOTE: Please make sure to refer to your plasma cutter's manufacturer instructions prior to attempting connection

## User Interface Basics:

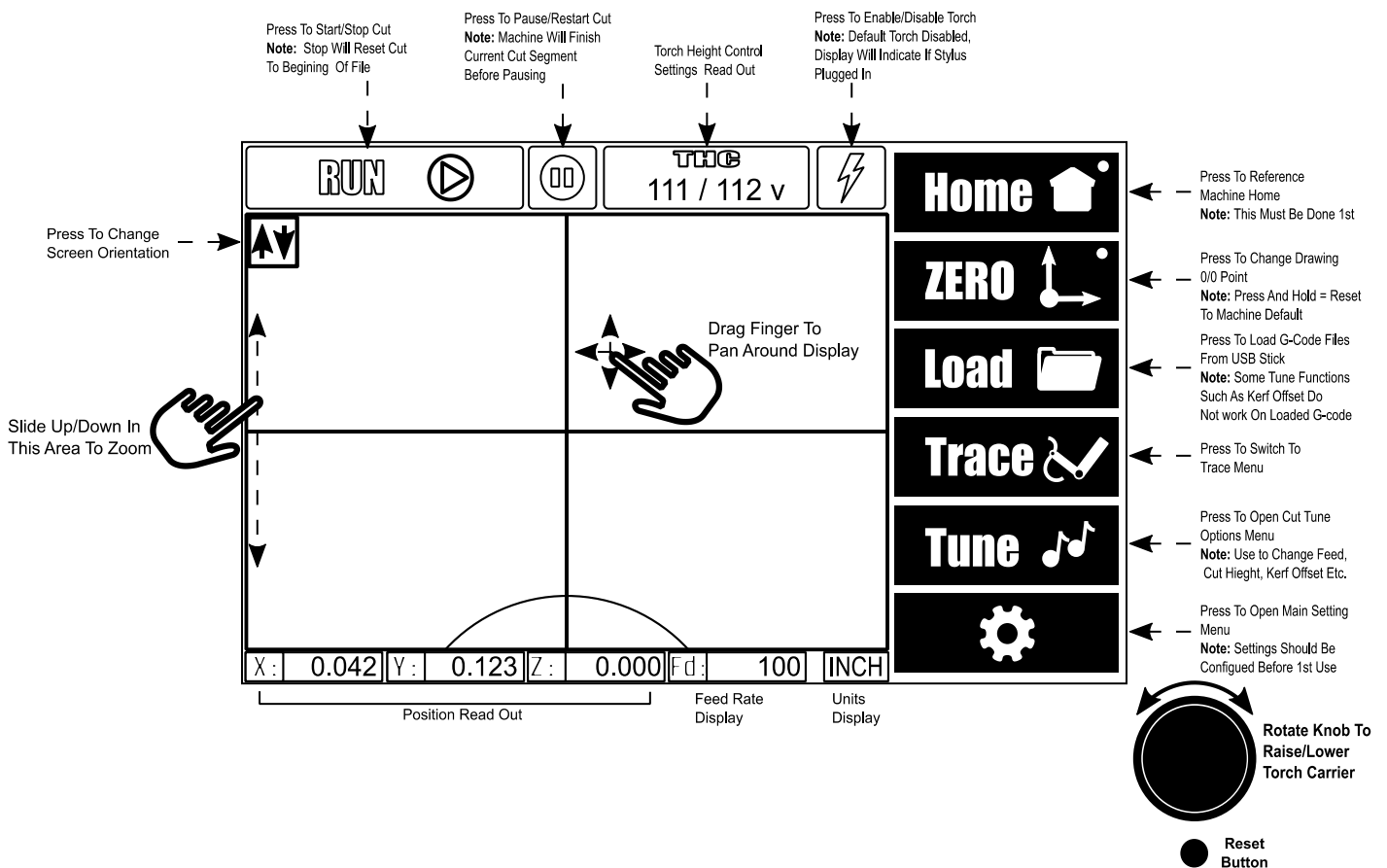

Visit [www.arcdroidcnc.com](http://www.arcdroidcnc.com) for more.

**Settings Screen:**

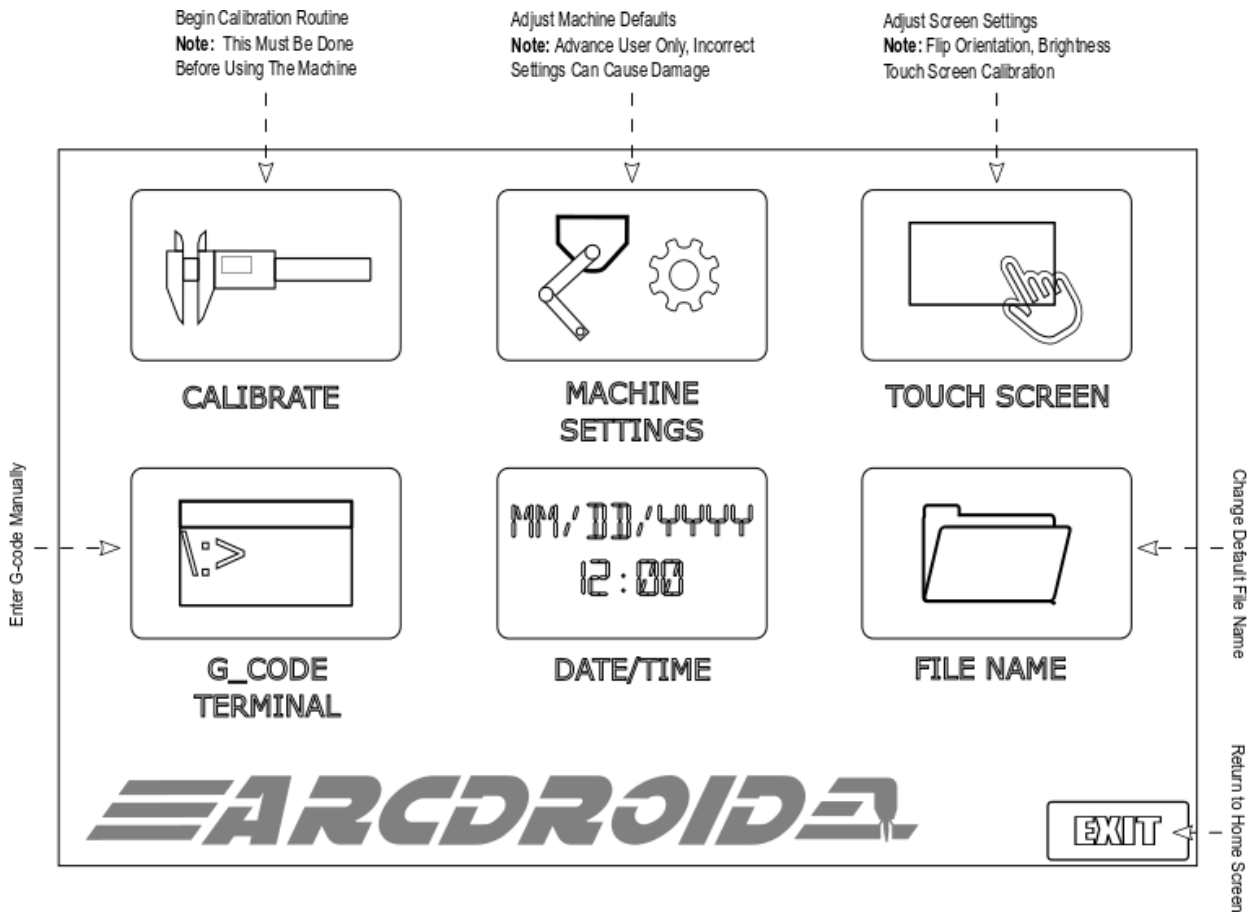

**Tune/Cut Settings Screen**

Toggle Inch/mm	Units	MM	
Cutting Feed Rate <b>Note:</b> Max Feed 5,500mm/m or 215 inch/m	Feed	1050	
Clearance Height <b>Note:</b> Tip Will Retract After Cut Finishes	Clear Z	15.00	
Pierce Height <b>Note:</b> Tip Will Rise After Probing And Hold For Prc Delay	Pierce Z	2.10	7 8 9 [X]
Cut Height <b>Note:</b> Tip Will Hold At This Height During Cutting	Cut Z	1.50	4 5 6 [↶]
Kerf Offset <b>Note:</b> When Importing File From USB Set To "0.0"	Kerf	0.40	1 2 3 [X]
Torch Pierce Delay <b>Note:</b> Torch Will Begin Cut Movement After Delay	Prc Delay	1.00	0 . [↶]
Torch Off Delay <b>Note:</b> Machine will remain motionless after cut to aid in cooling	Off Delay	0.10	[EXIT]



ARCDROID™ is a portable CNC robot with tracing features. Using Simple Trace™ user interface or with your PC the ARCDROID™ can repeat any pattern you provide. When paired with a Low Frequency plasma cutter, ARCDROID™ can be used to create detailed and accurate metal parts.

**Parameters:**

- Input voltage: 85—132VAC / 170-246 VAC 50/60 Hz (depending on model)
- Input : 3A Max current
- Working noise level: < 72 dBA @ 1m
- Working Envelope: 660mm x 38mm x 65mm
- Max feed rate: < 5,000mm/minute

DISTRIBUTED BY		
<p><b>Hare &amp; Forbes Machineryhouse</b> Sydney - Melbourne Brisbane - Perth</p> <p>Ph: 1300 202 200</p> <p><a href="http://www.machineryhouse.com.au">www.machineryhouse.com.au</a></p>	<p>Manual Download</p> 	<p><b>Machineryhouse</b> Auckland Christchurch</p> <p>Ph: 0800 142 326</p> <p><a href="http://www.machineryhouse.co.nz">www.machineryhouse.co.nz</a></p>
Made in China		

	
<p>CNC Robot For Plasma Cutter © 2 AM INNOVATIONS LIMITED Room 1115 11/F Tower A Regent Centre, 63 Wo Yi Hop Road Kwai Chung NT, Hong Kong MANUFACTURED IN CHINA</p>	
<p>Input voltage: 90-120 VAC 50-60 Hz Full-load Current: 3A Operational voltage: 24VDC 6A</p>	
<p>Model: 2AM-ADP-120-1.01 Serial#: <b>ADPR-22-00001</b> Year of Manufacture:</p>	
	
<p>7 93888 14474 3</p>	

### 1.1 Inspecting the Sled Slide Switch

Begin by inspecting the small metal Tang on the bottom of the Sled Slide Switch. Be sure that it is not bent or damaged in any way.

Next, verify that the Sled Slide Switch moves smoothly and freely along the triangular Calibration Tool Rails. If it binds or sticks at all, use a File to lightly dress the edges of the Slide. **ONLY MOVE THIS SLED IN THE FORWARD DIRECTION ALONG THE RAILS.**

Moving it backwards will DAMAGE the switch!



### 1.2 Calibrating the X / Y Axis

Begin by assembling your Calibration Triangle. There are merely (3) Cone-tipped Screws and (3) Rails that will be fitted together to form the Triangle.

Youtube Video  
Tutorial Link

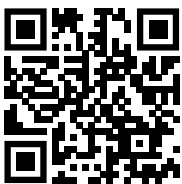

<https://youtu.be/tXZ8GQZlpPo>

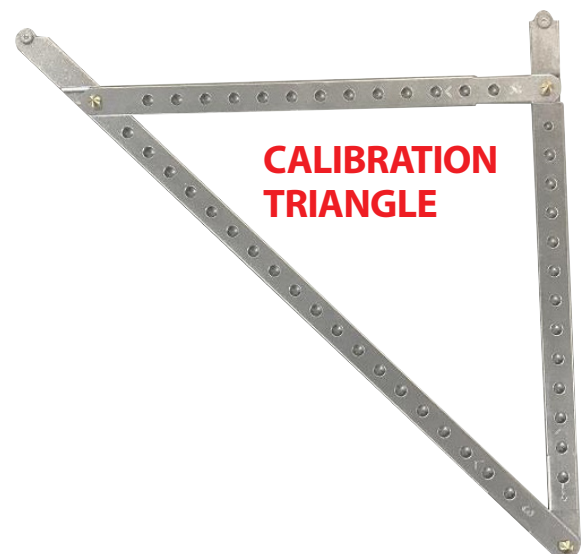

## 1.2 Calibrating the X / Y Axis cont.

**(NOTE: you can manually move the Robot's Arm by hand to position the arm as necessary)**

Place your machine on a FLAT and LEVEL surface. Check to be sure that your machine is LEVEL to the work surface using a level on the ArcDroid™'s Arm top surface. (label is on the arm for reference)

**NOTE: If your machine is not level with the work surface, you will have difficulty calibrating the machine properly.** Position the Calibration Triangle against the base plate of the ArcDroid™ with the round protrusions fitted into the cutouts on the front of the ArcDroid™'s base plate. Clamp the calibration triangle into place. Turn ON the power to your machine. At the main screen on the User Control Interface, press HOME. **(the machine will not do anything until this has been done.)**



**(NOTE: The User Control Interface is completely TOUCHSCREEN controlled.)**

At the User Interface Control, click on the SETTINGS GEAR icon at the bottom right corner of the screen.



## 1.2 Calibrating the X / Y Axis cont.

Next, click on the CALIBRATE icon



Follow the ON SCREEN INSTRUCTIONS to calibrate the machine as outlined below:



Plug a blank USB Memory Stick into the side of the User Control Interface. This is where the Calibration Data will be stored if needed later.

Attach the Stylus to the Robot Arm using the Quick Connect Bracket. (DO NOT plug the Stylus cable into the side of the ArcDroid™.) Position the Sled Slide Switch on Rail #1 of the Calibration Triangle. (The Triangle Rails are MARKED 1, 2, & 3) Plug the cable from the Sled Slide Switch into the port on the right side of the ArcDroid™.



## 1.2 Calibrating the X / Y Axis cont.

Manually move the Robot Arm, by hand, so that the Tip of the Stylus is hovering above the Cone on the Sled Slide Switch. Using the Rotary Knob again, dial the head down until the stylus is centered on the tip of the cone. Press NEXT on the control, as indicated in the on screen instructions. Now, with slight downward pressure, SLOWLY move the Sled down the rail towards the second Cone on the Triangle. The User Interface Control will show that it is capturing data and will guide you through the remaining steps of the calibration. Next, dial the stylus up away from the table again and lift the Sled off the rail and move it to the second rail. Bring the stylus back to the cone tip on the Sled Slide Switch and move the head down the second rail, slowly. Repeat this process on the final rail.

After this is performed, the control will prompt you to repeat the entire calibration process again, this time using the Plasma Torch Head mounted to the ArcDroid™. Once completed, the machine will automatically SAVE and SET the new machine parameters and HOME itself.

To VERIFY your Calibration, remove the Sled Slide Switch and install and plug in the Stylus to the ArcDroid™.

Next, manually move the robot arm and stylus to the Calibration Triangle CONE TIP at the left side of rail #2.

Once the Stylus is locked into the cone tip, click the ZERO icon on the User Control Interface Home Page. (verify that your X and Y Coordinates both read ZERO at the bottom of your screen)



Now, manually move the robot arm and stylus to the CONE TIP at rail #3. (the cone tip at the furthest position from the face of the ArcDroid™).

**NOTE: The Cone Tips on the Calibration Triangle are EXACTLY 313mm or 12.3228" apart.**

Look back at your User Interface Control Screen and verify that the X and Y coordinates are now reading 313mm (approx. 12.322"). If so, then you are properly Calibrated!

**(NOTE: if your dimensions are within 0.05mm or 0.002", this is acceptable)**

If not, repeat the entire Calibration process again until you achieve the proper results.



## 1.3 Calibrating the Z Axis

Youtube Video  
Tutorial Link



<https://youtu.be/udinid0vk64>

This Z Calibration is critical in order for settings such as PIERCE HEIGHT, CUT HEIGHT, and CLEAR HEIGHT to be accurate distances from your work piece when running programs.

Plug in your Stylus to the User Interface Control Unit and attach your stylus to the ArcDroid™ using the quick connect bracket.

Using any small flat piece of metal, measure the thickness of the metal and make note of the exact measurement.

Position your Stylus anywhere on your worktable and SET ZERO at the Control.

At the User Interface Control, click on TRACE. Click on the CIRCLE icon and press the button on the rotary dial to enter the Circle Edit Dimensions page. Enter simple dimensions to create a small circle, maybe 0.5" diameter, at the X,Y ZERO position. Click on the CHECK MARK to confirm. Now, Click on the SETTINGS icon. In the CLEAR Z setting, set this equal to the exact THICKNESS of your small flat metal piece. Click the CHECK MARK and then the EXIT buttons on the control. Click SAVE to go back to the home screen.

Your Stylus should still be plugged into the ArcDroid™. If so, the machine is already in DRY RUN MODE. REMOVE your small metal piece from the worktable and RUN the Program in DRY RUN MODE. Once the machine completes the dry run of cutting a small circle, the Stylus will return to the CLEAR Z height that you entered on the Settings page. Using the small metal piece that you previously measured, try sliding the metal piece under the Stylus. If your metal piece fits snugly, then your Z AXIS is calibrated correctly. If it does NOT fit, then you must adjust the backlash of the Z AXIS as follows:

**(NOTE: ALL of the Machine Settings are measured, and should be entered, in Millimeters, regardless of whether or not you have selected INCHES or MM on the TUNE page)**

Do your best to measure the difference between the small metal piece and the tip of the Stylus.

On the ArcDroid™, click on SETTINGS ICON, then MACHINE SETTINGS. Scroll down to PROBE OFFSET. Choose the Z PROBE OFFSET and ENTER the measured difference by adding or subtracting from the number previously entered. Press the CHECK MARK, the press the BACK ARROW to exit the SETTINGS page and be sure to SAVE the new settings. Return to the home screen and re-run the Circle program to retest the Z CLEARANCE height. REPEAT IF NECESSARY until you achieve the proper Z CLEARANCE HEIGHT matching the thickness of your small sample metal piece.

## 2.0 Connecting your Plasma Cutter to the ArcDroid™

### Connecting with CNC cable

If your plasma is equipped with a built-in CNC remote start Port, then it is simply a matter of using the **correct** CNC cable from the CNC Port on your plasma machine to the two TORCH START INPUT Screw Terminals on the rear of the ArcDroid™.

**WARNING :** If this connection is not connected in accordance with your specific plasma machine the CNC port output voltage could cause significant damage to the ArcDroid™ or your Plasma unit. Please always check with your plasma supplier to confirm the correct wiring before proceeding.

Below are 2 examples for the most popular Plasma units sold in Australia & New Zealand.

**Beware other brands may look similar but the pin configuration could be different !!**

**Example 1 :** This cable configuration suits UNIMG RAZOR 45, 80 & 120 as well as HYPERTHERM Powermax Series.

Connect spade terminals FT1 & FT2 to the TORCH connections on the terminal strip on the rear of the ArcDroid™.

\*\* Important – Ensure all remaining non connected spade terminals of the cable are individually insulated with heat shrink or electrical tape.

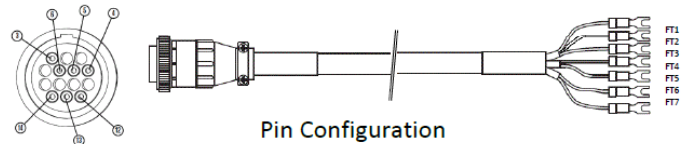

14 Pin Round	Function	Fork Terminal
3	Start	FT1
4	Start	FT2
5	Divided Voltage (-)	FT3
6	Divided Voltage (+)	FT4
12	Transfer	FT5
13	Ground	FT6
14	Transfer	FT7

**Example 2 :** This cable configuration suits STRATA AvancedCut 75 & 125 Plasma machines

Connect spade terminals FT1 & FT2 to the TORCH connections on the terminal strip on the of the ArcDroid™..

\*\* Important – Ensure all remaining non connect spade terminals of the cable are individually insulated with heat shrink or electrical tape.

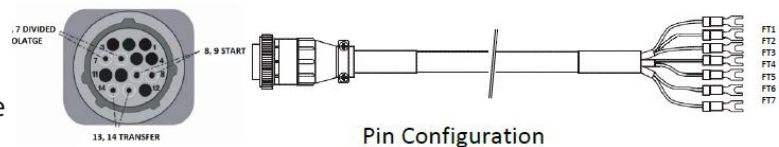

14 Pin Round	Function	Wire Colour	Fork Terminal
8	Start	Yellow	FT1
9	Start	Green	FT2
7	Divided Voltage (-)	Black	FT3
6	Divided Voltage (+)	Red	FT4
13	Transfer	Blue	FT7
14	Transfer	White	FT5



## 3.0 Setting up the ArcDroid™ to run

- 1) TURN ON THE MACHINE
- 2) PRESS "HOME" ON THE CONTROL PANEL (the machine will not do ANYTHING until it has been HOMED)
- 3) PRESS "TUNE" ON THE CONTROL PANEL

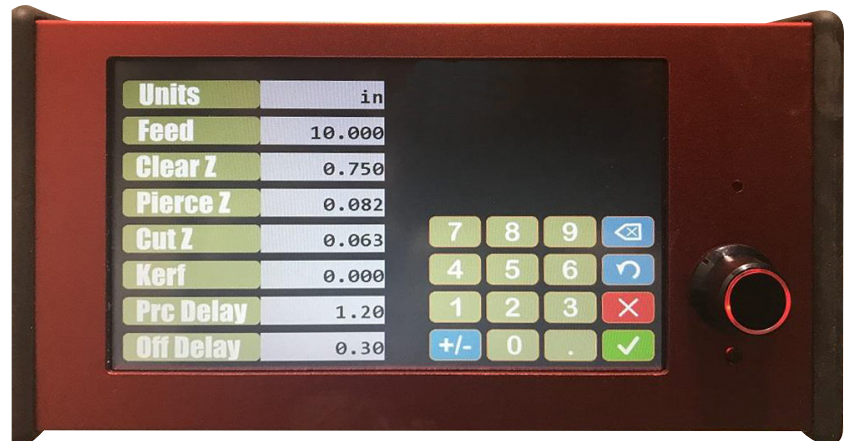

- SET UNITS (mm or inches)
- SET FEED RATE ACCORDING TO YOUR PLASMA MACHINE SPECS & MATERIAL BEING USED
- SET CLEAR Z (Torch Clearance Height between cuts)
- SET PIERCE Z (Torch Height when beam is turned on)
- SET CUT Z (Torch Height when cutting)
- SET KERF (adjust as necessary to account for Torch Cut Width)
- SET PIERCE DELAY (Time to penetrate metal before beginning cut move)
- SET PIERCE OFF (time Torch is OFF between cuts – aids in cooling)

CLICK THE "CHECK MARK" to CONFIRM and SAVE SETTINGS.

### 3.1 Establish X,Y ZERO POSITION of your workpiece

Youtube Video  
Tutorial Link

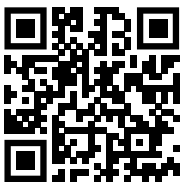

<https://youtu.be/-f-mgaNABeM>

Attach your Plasma Cutter's Torch handle to the Quick Release Handle Bracket included with your ArcDroid™. There are just (2) Screws to be loosened to fit your torch handle and retightened to keep the torch in place.

If you are planning to cut a part from a blank piece of metal, then place your metal on your worktable and clamp the work to the table. Be sure to connect your Ground Clamp to the actual workpiece and not just the table. Move the Robot Arm to a clear solid area of the metal workpiece and ZERO the machine at the User Interface Control to establish your X,Y Starting point.

If you have an existing part that you would like to modify by adding a cut feature, then you will first need to clamp your workpiece to the table. If your part is square or rectangular, you should also square the part to the base of the ArcDroid™. (Using a Carpenter's Square is an easy method of doing this) Next, either measure your part and mark the position where you would like to Start your Cut, or use a Tool such as the **Corner Wizard** for ArcDroid™, to establish the precise X/Y Zero starting point. ZERO the machine at the User Interface Control. You are now ready to create your Cut Program or Load an Existing Program to cut.

**(NOTE: your Robot's CURRENT POSITION coordinates are shown at the BOTTOM of your screen)**

## 4.0 Using Simple Trace™

### 4.1 Creating Cut Files on the ArcDroid™

- 1) Press "TRACE"
- 2) Choose Circle, Rectangle, or Line Draw/Trace ICON.

Youtube Video  
Tutorial Link



<https://youtu.be/djM6Sf2D9Tg>



- 3) Press the BUTTON on the Rotary Knob to enter the Feature Edit Mode.
  - a) For CIRCLE, fill in the Feature Specs as follows:
    - LEAD (enter length dimension for lead-in to cut)
    - ENT (click to change your Entry Direction)
    - D (enter DIAMETER of your Circle)
    - X (x coordinate) Y (y coordinate)
    - CUT (click to change your Cut Side)

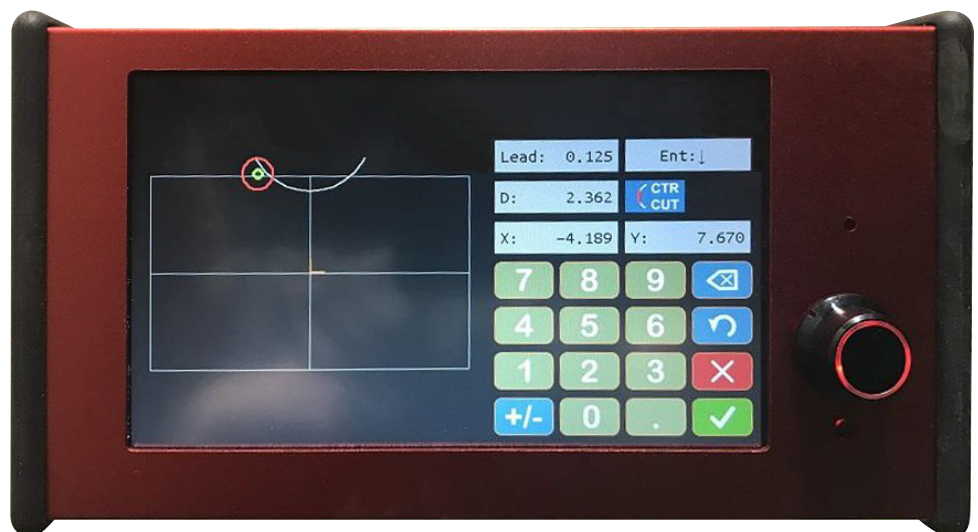

Press CHECK MARK to confirm and exit feature.

**(NOTE: at any given time, you may hit the UNDO icon above the RED X on your screen to UNDO your last command)**

## 4.1 Creating Cut Files on the ArcDroid™ Cont.

b) For RECTANGLE, fill in the Feature Specs as follows:

CUT (click to change side of your cut)

ENT (click to change your Entry Position)

ORI (click to change your feature position according to your X,Y Origin)

A (set your ANGLE of the feature)

LEAD (enter length dimension for lead-in to cut)

W (enter WIDTH of your Rectangle)

H (enter HEIGHT of your Rectangle)

X (x coordinate)          Y (y coordinate)

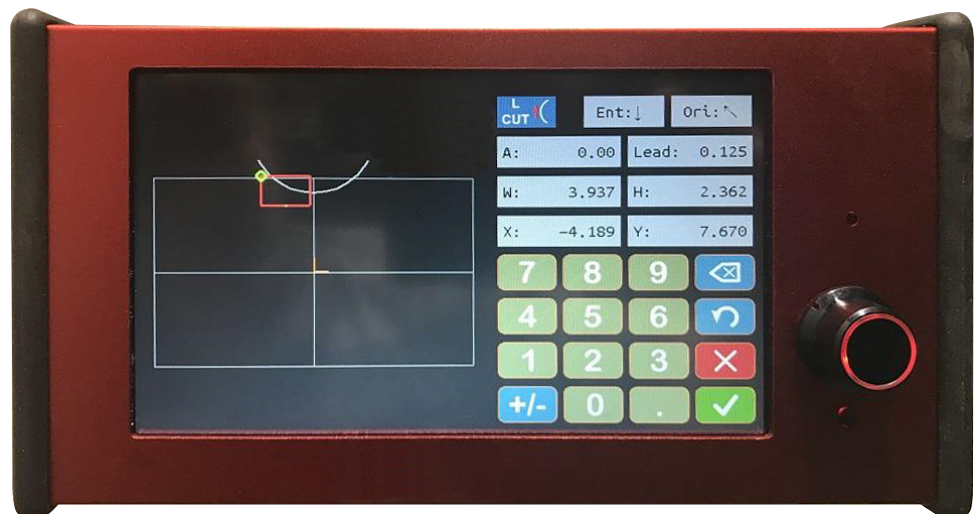

Press CHECK MARK to confirm and exit feature.

c) For Line Draw/Trace, do the following:

Make sure your Stylus is plugged into the ArcDroid™.

Position the Stylus at the exact Starting Point of your Trace.

If drawing a line, click the button on the stylus to confirm the starting point. Move the Stylus to the next point and click the stylus again to confirm the line point. Repeat these steps until your shape is complete and then DOUBLE-CLICK on your last point to end the drawing.

- If tracing a shape, HOLD the button on the Stylus while tracing your shape and release the button at the endpoint. REPEAT above as necessary to complete your shape.

**Be sure to DOUBLE-CLICK at the end of your trace.**

Remember to click on the CHECK MARK at the bottom of the screen to confirm.

4) Once all features have been entered, click on the DISK ICON to SAVE your program. Then once saved, press the EXIT icon.

Once you have entered all your desired features and are ready to RUN the program, ALWAYS perform a DRY RUN before cutting! To do this, make sure that the LIGHTENING ICON at the top of your screen is DISABLED. The LIGHTENING BOLT will have a RED CIRCLE with a LINE through it, indicating that it is DISABLED. Once disabled, you can press on the RUN icon to start your DRY RUN and confirm that everything looks good before cutting. To re-enable the Plasma Torch, simply click the LIGHTENING BOLT ICON once again.

## 4.2 Editing Cut Files on the ArcDroid™

If you need to change the data contained within any of the features that you have created in your program, you can simply CLICK on the FEATURE that needs to be changed and then click the EDIT ICON at the TRACE MENU. You can also DELETE this feature entirely by clicking on the feature and then clicking on the UNDO icon.

Be sure to CONFIRM the change by clicking the CHECK MARK and be sure to RESAVE your changes when exiting the EDIT screen.

## 4.3 Loading Cut Files on the ArcDroid™

To load a previously saved program from a USB Memory Stick into your ArcDroid™'s control, plug the USB Stick into the side of the User Interface Control and then click on the LOAD icon at the HOME SCREEN. You will see a list of programs on the screen. You may click on any of the programs and that program will load immediately and return you to the Main Screen. If there are a lot of programs stored on the USB Memory Stick, you will also see UP / DOWN Scroll Arrows at the right side of the screen. You can click on these arrows to navigate through the full list of available programs.

**Note:** In order to Avoid mathematical errors when loading files set your "Kerf " to "0.0" in the TUNE menu before loading.

The ArcDroid™ has a file limit of approximately 3500 lines. Some CAD/CAM software will produce unnecessarily large files. Reduce line segments or spline tolerance in your CAM software to decrease the size of the file before attempting to load.

## 5.0 Programming via Computer

ArcDroid™ can be operated using imported .gcode files from programs such as Fusion 360, SheetCAM or Pronest. Please see our YouTube channel for quick tutorial.

Youtube Video  
Tutorial Link



<https://www.youtube.com/watch?v=cfY88XqPWwA>

## 6.0 Manual G-CODE Entry on the ArcDroid™

In addition to writing complete G-CODE Programs at a PC, the ArcDroid™ will also accept direct entry commands on the ArcDroid™.

To manually enter G-CODES or M-CODES, simply click the GEAR ICON at the Home Screen and then click the G-CODE TERMINAL icon.

From here, you can type any acceptable G-CODE or M-CODE and necessary parameters for each code and the machine will immediately perform the requested function.

e.g. If you type G28, the machine will return to its' HOME POSITION.

(a complete list of acceptable G-CODES and M-CODES can be found in SECTION 8.0 of this manual.)

## 7.0 Setting the System Date & Time

At the HOME SCREEN, click on the SETTINGS icon and then the DATE TIME icon. Here, you can enter the appropriate Date and Time.

## 8.0 ArcDroid™ G-CODE & M-CODE Reference List

G0: .....Rapid Linear Move  
G1: .....Linear Move using a FEED RATE  
G2: .....Arc CLOCKWISE  
G3: .....Arc COUNTER-CLOCKWISE  
G4: .....Dwell  
G20: .....Inch Units  
G21: .....Millimeter Units  
G28: .....Optional Home  
G30: .....Single Z-Probe  
G54-G59: .....Workspace Coordinate System  
G80: .....Cancel Current Motion Mode  
G90: .....Absolute Positioning  
G91: .....Incremental Positioning  
G92: .....Set Z Position Including Probe Offset (G92 Z0 P1)

---

M0: .....Unconditional Stop  
M3: .....Turn ON Plasma Beam  
M5: .....Turn OFF Plasma Beam  
M444: .....Set Cutting Delays (M444 S1.200 P0.300) sets Pierce Delay at 1.2sec & Beam OFF delay at 0.3sec before next cut)  
M17: .....ENABLE Stepper Motors (LOCK ROBOT ARM)  
M18:..... DISABLE Stepper Motors (END of Program)

---

## 9.0 Pro Tips

- To reorient the screen in relation to the ArcDroid™ depending on whether you are standing in front or behind, simply click on the RED/WHITE ARROW icons at the top left of the drawing area.
- The left side of the drawing area acts like a ZOOM slider
- To PAN press anywhere in the middle of the drawing area and drag to move about the image about.
- For increased accuracy a non-scratching stylus such as the kind used for phones or tablets can be used on the screen.
- The BUTTON on the STYLUS and the BUTTON on the center of the Rotary Control Knob can be used interchangeably
- To clear the screen during a trace press and hold the undo button for 4 second
- At the front of the Robot's Arm, the Receiving Bracket for the Quick Connect Mount has (2) attaching screws. If you remove these (2) Screws, you can Raise or Lower the Receiving Bracket to accommodate height differences between your work surface and your Plasma Torch Head.

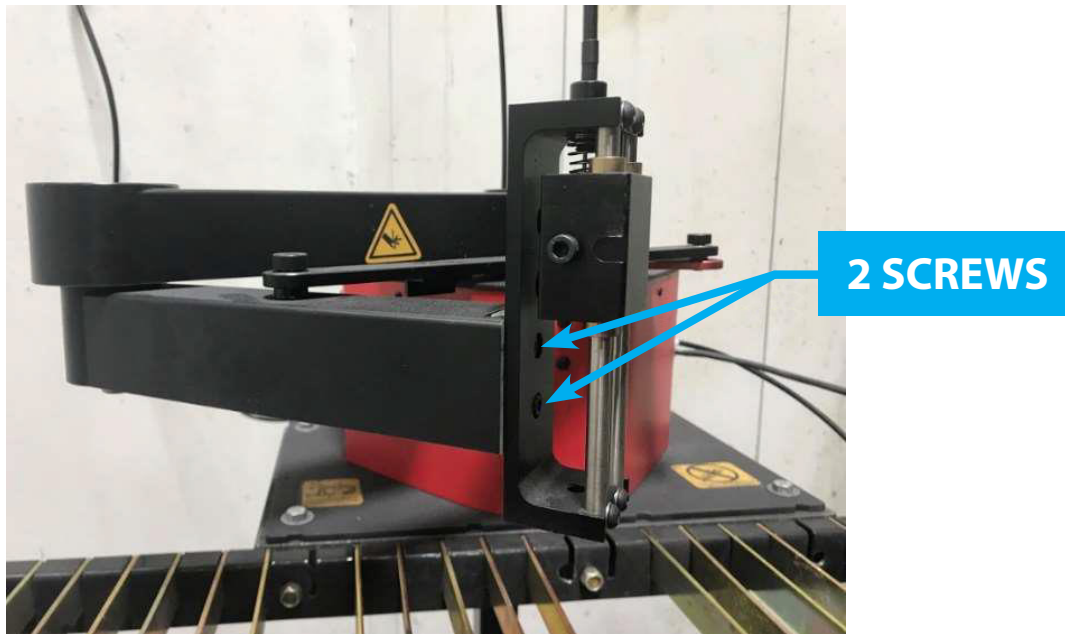

- If using the LINE DRAW / TRACE function, note the OPEN / CLOSE icon on your screen. If OPEN, the ArcDroid™ will NOT connect your start and endpoints. If CLOSED, it will add a line, connecting that last point drawn to the first point of your sketch.
- When Cutting complex parts use the "Off Delay" setting in the tune menu to have ArcDroid™ pause after each cut to allow your plasma cutter to cool and your compressor to catch up

## 10.0 Troubleshooting and Maintenance

Problem	Possible cause	Remedy
Imported G-code file not displaying or displaying improperly	<ul style="list-style-type: none"> <li>• Kerf offset on ArcDroid™ not set to '0"</li> <li>• File size too large/ improperly formatted</li> </ul>	<ul style="list-style-type: none"> <li>• Ensure kerf is set to "0" before importing any G-code file to avoid ArcDroid™ adding new offset</li> <li>• Check file size (3500 line limit) change resolution settings in CAM program to reduce unnecessary lines.</li> </ul>
Torch does not turn on	<ul style="list-style-type: none"> <li>• Torch disabled in software</li> <li>• Improper wiring</li> </ul>	<ul style="list-style-type: none"> <li>• Ensure torch is enabled on screen (red lines absent from lightning bolt)</li> <li>• Check torch trigger wiring (refer to plasma cutter manufacturer instructions)</li> </ul>
No Power/ screen does not light up	<ul style="list-style-type: none"> <li>• Blown fuse</li> <li>• Bad communications cable</li> </ul>	<ul style="list-style-type: none"> <li>• Check fuse on power entry port (5 A)</li> <li>• Replace communications cable ( Cat6 2m Ethernet cable)</li> </ul>
Touch screen not responding or buttons difficult to activate	<ul style="list-style-type: none"> <li>• Touch screen has lost calibration</li> <li>• Debris on screen or stuck in bezel</li> <li>• Touch screen physically damaged</li> </ul>	<ul style="list-style-type: none"> <li>• Recalibrate touch screen Settings -&gt; Touch Screen -&gt; Calibrate Touch</li> <li>• Reset screen insert USB drive with empty file labeled "reset.txt" and reboot machine</li> <li>• Clean screen and inspect for damage such as burn marks or deep scratches. Contact Service for replacement if required</li> </ul>
Inaccurate cuts	<ul style="list-style-type: none"> <li>• Bad calibration</li> <li>• Loose belts or pulleys</li> <li>• Bad torch mounting or worn consumables</li> </ul>	<ul style="list-style-type: none"> <li>• Run calibration routine</li> <li>• Check belt tension (two small holes in front)</li> <li>• Test for tension or Pulley slippage Settings -&gt; G-code terminal -&gt;M17 Send to lock arms and test for play</li> <li>• Check that torch is attached securely and square to work</li> <li>• Replace worn consumable tips on plasma torch</li> </ul>
Z travel sticking / unpredictable	<ul style="list-style-type: none"> <li>• Torch lead interfering with movement</li> <li>• Rails not clean/lubricated</li> <li>• Cable kinked/damaged</li> </ul>	<ul style="list-style-type: none"> <li>• Be sure to support the torch cables when moving/cutting</li> <li>• Clean rails and apply light lubrication</li> <li>• Inspect drive cable for damage call service for replacement if needed</li> </ul>
ArcDroid™ resets on torch start	<ul style="list-style-type: none"> <li>• Incompatible High Frequency Start plasma cutter</li> </ul>	<ul style="list-style-type: none"> <li>• Replace with low frequency start "blowback" style plasma cutter</li> </ul>
ArcDroid™ cuts wildly or moves suddenly after torch start	<ul style="list-style-type: none"> <li>• Incompatible High Frequency Start plasma cutter</li> </ul>	<ul style="list-style-type: none"> <li>• Replace with low frequency start "blowback" style plasma cutter</li> </ul>

### Maintenance:

- Visually inspect your ArcDroid™ For damage or wear before ever use. Damaged or worn out components should be replaced immediately
- Z slides should be cleaned and lightly lubricated regularly
- Check belt tension monthly via the tensioner access holes in the front of the machine.



For More Help:

Visit us online at [www.arcdroidcnc.com](http://www.arcdroidcnc.com)

Or Email: [info@arcdroidcnc.com](mailto:info@arcdroidcnc.com)